

LANCING DEVICE and TWIST LANCET

TD-5010

TaiDoc's Lancing Device is designed with more comfortable grip, different depth selections, and twist-release cap. It provides more convenient, more comfortable, and easier operation for the users.

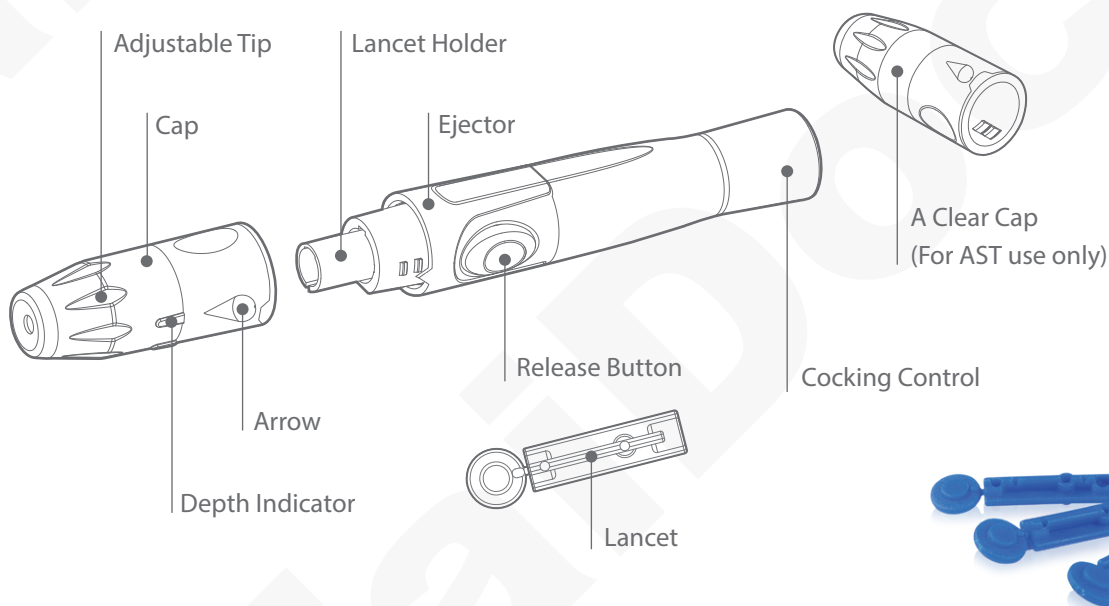

FEATURES

- Twist-Release provides safer and easier operation for users.
- 6-level depth selection. More noticeable clicks between each level.
- The lancet can be ejected anytime.
- Large contact area – provides steady and comfortable puncture.
- Better adjustable tip grip
- Large holding area on the cap
- Status display on the release button is more visible
- Less vibration less pain

SPECIFICATIONS

LANCING DEVICE

Model Number: TD-5010

Penetration Depth Setting: 6-level comfort dial

Penetration Range: 0.8 mm to 1.8 mm

Dimension: 118.7 (L) x 17.5 (D) mm

Weight: 16.5 g

Priming of Device:

Push button to prime with status display window

Lancet Ejection: Yes

Alternative Site Testing: Yes

Quality Compliance

ISO 11137, ISO 11737,
ISO 10993-10:2002/Amd 1:2006,
ISO 10993-5:2009

ISTA 2A Compliance

ASTM E171, ASTM D4332,
ASTM D642, ASTM D999,
ASTM D5276

TWIST LANCET

Model Number: TD-5084

Lancet Gauge: 30G

Weight: 0.4g

Dimension: 32.6mm x 6.4mm

Units per Carton: 100 pcs/box and 140 boxes/carton

Net Weight per Carton: 7.62 kg

Gross Weight per Carton: 8.62 kg

INSTRUCTION FOR USE

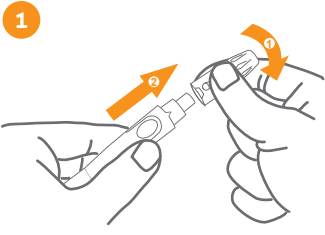

1 Twist and pull off the cap of the lancing device.

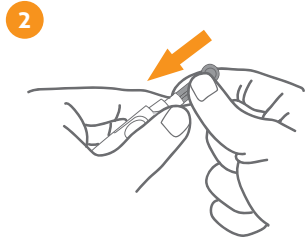

2 Insert a lancet into the lancet holder and push down firmly until it is fully secured.

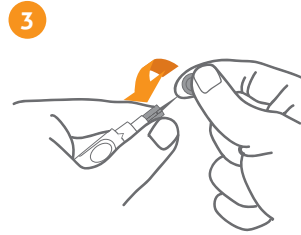

3 Twist the protective disk off the lancet.

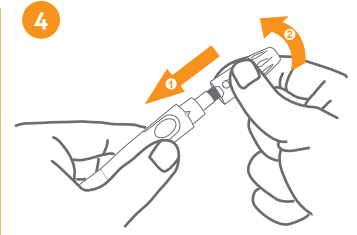

4 Replace and twist the cap as shown in the picture.

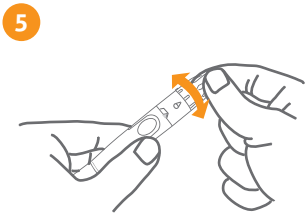

5 Select the depth of penetration by turning the adjustable tip in either direction so that the arrow on the cap points to the desired depth.

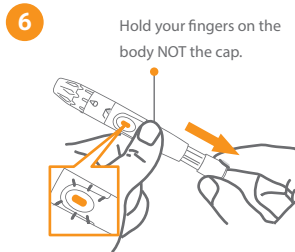

6 Hold your fingers on the body NOT the cap. Pull the cocking control back until it clicks. You will see a color change inside the release button when it is ready.



7 Lancing the finger
Press the lancing device's tip firmly against the lower side of your fingertip. Press the release button to prick your finger, then a click indicates that the puncture is complete.



8 Remove the device from the puncture site. After penetration, remove the first drop of blood with a clean cotton swab. Gently squeeze the punctured area to obtain another drop of blood. Be careful NOT to smear the blood sample. Apply the blood to the test strip.

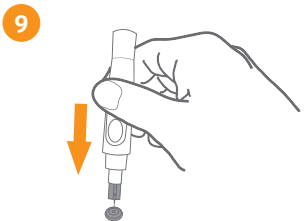

9 Remove the lancet by pulling the cap off first. Safely dispose of the used lancet by placing the protective disk on a hard surface, and pushing the exposed tip into the disk.

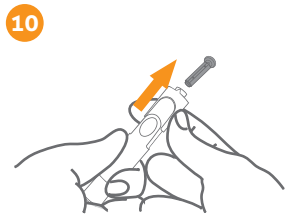

10 Slide the ejector forward to remove the used lancet. Dispose of the lancet according to your local regulations.



www.taidoc.com

TaiDoc Technology Corp.

B1-7F., No.127, Wugong 2nd Rd., Wugu Dist.,
New Taipei City 24888, Taiwan
Tel: +886-2-6625-8188 Fax: +886-2-6625-0288